

Stile Medicine Cabinet Item # M051

Features:

- Surface-mount or recessed medicine cabinet with mirrored door
- Three adjustable glass shelves
- Concealed European hinges and wooden mounting cleat
- Cabinet can be reversed to open on left or right
- Customizable (please request a quote)
- Handmade in USA
- Manufactured with low VOC finishes and wood from renewable forests



Finish Options:

- 02 - Natural Cherry
- 06 - Wedge
- 07 - Natural Walnut
- 08 - Matte White (TEX1 - fine texture)
- 16 - Matte Black (TEX1 - fine texture)
- 18 - Ebony
- 20 - Ash Gray
- 22 - Gray Zebra
- 24 - Classic Walnut
- 31 - White Oak
- 33 - African Mahogany
- 34 - Matte Mocha (TEX1 - fine texture)
- 35 - Matte Ardesia (TEX1 - fine texture)
- 36 - Espresso
- 37 - Weathered Oak
- 52 - Silver Oak
- 85 - Gloss White
- 86 - Gloss Black
- 87 - Gloss Mocha
- 88 - Gloss Ardesia

Product Specifications:

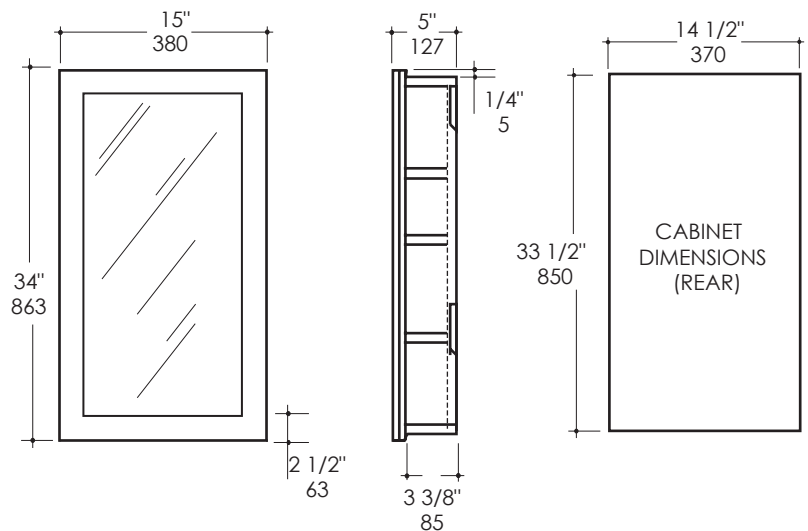

Notes:

Drawings provided herein are meant to give the user an idea of the product and are not made to scale. The size in inches is rounded up to the nearest 1/16". Slight variances can often occur with porcelain and woodwork. Therefore, LACAVA will not be held responsible for any cutouts, countertops, or furniture made without the actual product or template from LACAVA. Differences in color, grain, appearance and texture are inherent in all natural woodwork, and should be expected. Variances in these qualities are not deemed manufacturing defects, and will not be accepted as valid reasons to return or exchange any LACAVA woodwork. Plumbing specifications are only a guideline and may need to be altered based on the application.

Product specifications are not binding to the manufacturer and can be changed without notice at any time. Please refer to your shipment for product final sizes.

LACAVA is committed to the highest level of customer service. Please feel free to contact us at 1-888-522-2823 (toll free) or by email at info@lacava.com for technical assistance or any general inquiries.

Rev. 12-11-2017